



**AWB 210** (Version: AMOSAWB210OP20231109)

**Water bath**

**Operation Manual**

AMOS SCIENTIFIC PTY.LTD. ABN37 159 778 140

[www.amos-scientific.com](http://www.amos-scientific.com)

# Foreword

Thank you for purchasing our AWB210 Water Bath. This operation manual introduces product functions, application methods and matters that need attention for safety. Please read in detail before operation to understand its performance and make full use of its functions. If you have any inquiries, please contact us, we are committed to delivering exceptional service whenever you need it.

After reading, please keep this manual properly for later reference.

# Contents

1. Safety Instruction.....	1
1.1 Safety Matters.....	1
1.2 Conditions of installation.....	1
1.3 Delivery Inspection.....	1
2. Performance Features & Range of Application.....	1
3. Main structure.....	3
4. Technical Parameters .....	3
5. Operation Guide.....	3
5.1 Keypad Description & Function.....	3
5.2 Instructions.....	3
6. Component Layout & Electric Wiring Diagram.....	4
7. Schematic Diagram.....	5
8. Cleaning & Maintenance .....	6
9. Trouble shooting.....	6

## 1. Safety Instruction

### 1.1 Safety Matters

- Please read these brief guidelines. Failure to adhere to these instructions may disrupt the equipment's regular operation, lead to equipment damage, or pose safety risks.



Please use 220VAC  $\pm$  10% at 50HZ or 110v $\pm$ 10%, 60Hz AC.



Input power supply must be of good earth connection.



Keep away from any flammable or explosive materials.



Unauthorized equipment access risks high-voltage shock.



Only professional maintenance personnel may perform equipment repairs.



Use fuses with correct capacity.



Ensure the power socket and circuit can withstand at least twice the rated current.



Keep away from potential sources of interference.



Caution: Hot.

- **Electrical Protection Ratings: I class, B type**
- **Shell protection grade: IP53**
- **Harmful liquid Leak-in proof degree: Normal (enclosed equipment without liquid leak-in proof)**
- **Working system: Continuous operation**

### 1.2 Conditions of installation

- Provide at least 20cm of space around the equipment for proper heat dissipation.
- No water drop, steam, dust (including oily and airborne).
- No erosive, flammable and explosive gas and liquid.
- Stable and free from vibration.
- No interference from other electromagnetic signals.
- Operate within ambient temperature of 5°C-40°C and relative humidity under 90%.

### 1.3 Delivery Inspection

The product undergoes rigorous quality inspection before leaving the factory. However, negligence or severe impact during delivery may result in damage or partial loss, please check the followings:

1. Upon unpacking, please inspect the contents, including the equipment, operation manual,

- packing list, and spare parts.
- 2. Check the nameplate to verify that it corresponds to your order.
- 3. Ensure that there is no damage or loss during the delivery process.

## 2. Performance Features & Range of Application

The Water bath is made of sheet aluminum, in aesthetically pleasing design, contactless temperature control, stable performance, a program control system, and easy and reliable operation. It is primarily employed for stretching and flattening of the microtome sections of tissues.

## 3. Main structure

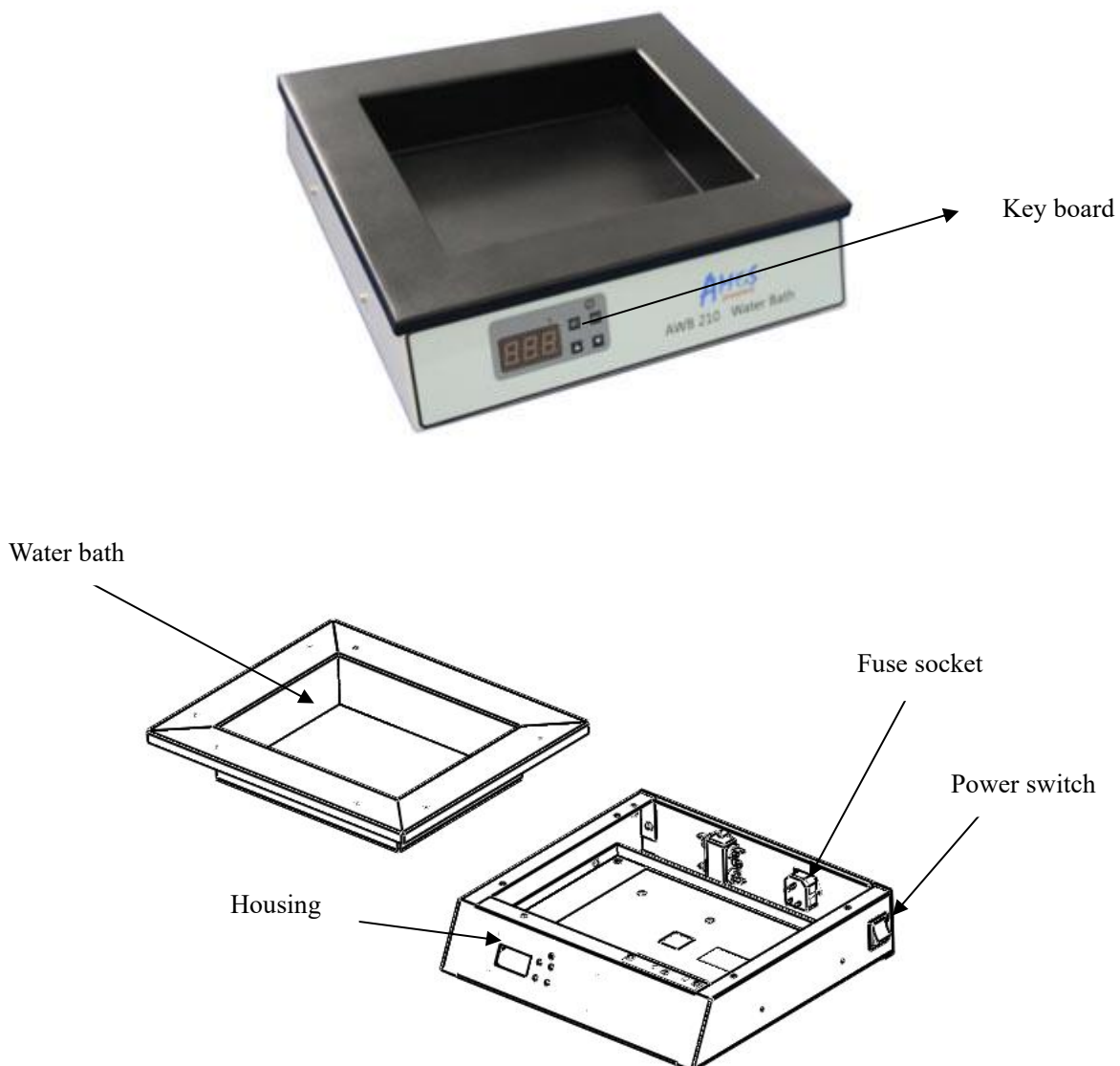

## 4. Technical Parameters

- Capacity: 2.3L
- Water bath chamber dimensions(mm): 230\*180\*56
- Temperature Range: ambient temperature ~75℃
- Temperature Control Accuracy: ±1℃
- Rated Voltage: 220VAC±10% at 50Hz (110V±10% at 60Hz)
- Fuse: 220V/3A (110V/5A)
- Rated Power: 350W
- External Dimensions (mm): 328(W) ×300(D) ×85(H)
- Weight: 2.4kg

## 5. Operation

### 5.1 Keypad Description & Function

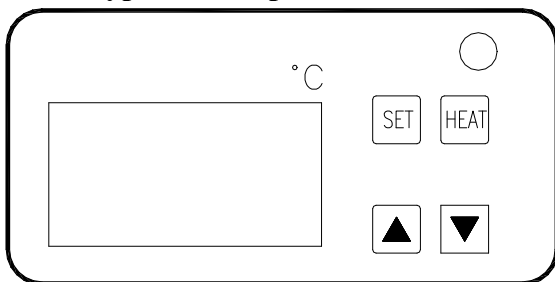

**SET** Press this button for temperature setting; a single buzz confirms operation.

**HEAT** Press this button to start heating, red indicator lamp will light; press again to stop heating.

**▲** Adjust temperature by pressing this button; a single buzz confirms successful operation for increasing temperature.

**▼** Adjust the temperature by pressing this button; a single buzz confirms successful operation for decreasing temperature.

### 5.2 Instructions

- Before operation, ensure every part of the equipment is in good condition.
- Plug in the equipment, switch on power at the rear, and listen for the buzzer. The LED screen will display the ambient temperature, and the green indicator light confirms normal operation.
- Press **SET** to set temperature, press **▲** **▼** to adjust temperature.
- Press **HEAT** to start heating.

After completing work, turn off the power switch and unplug the power.

## 6. Component Layout & Electric Wiring Diagram

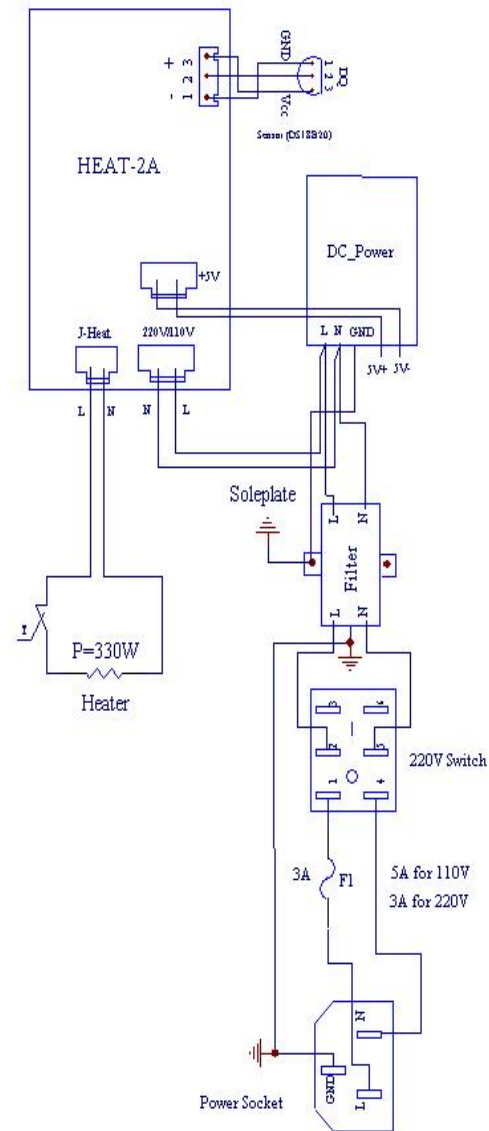
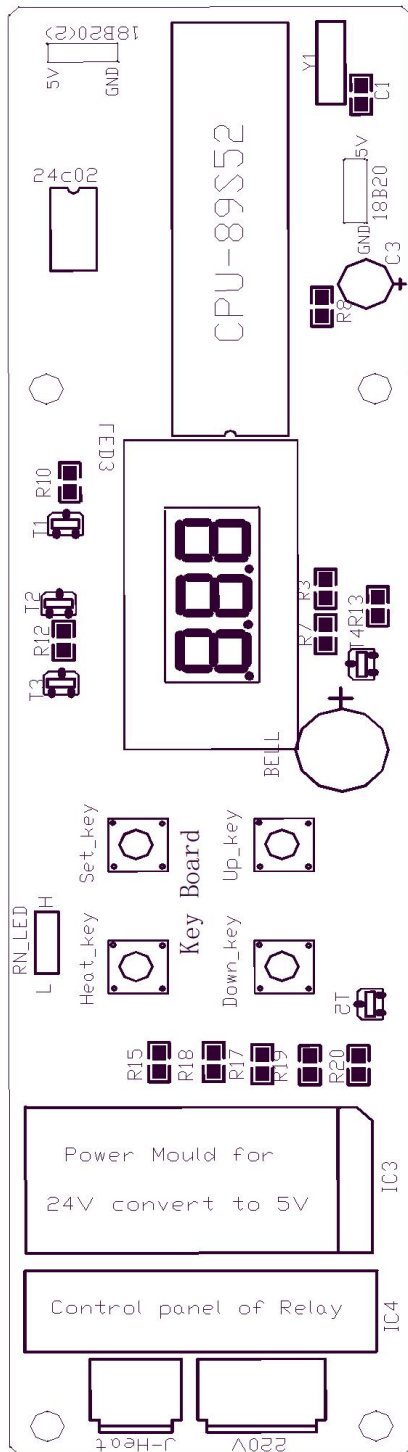

## 7. Schematic Diagram

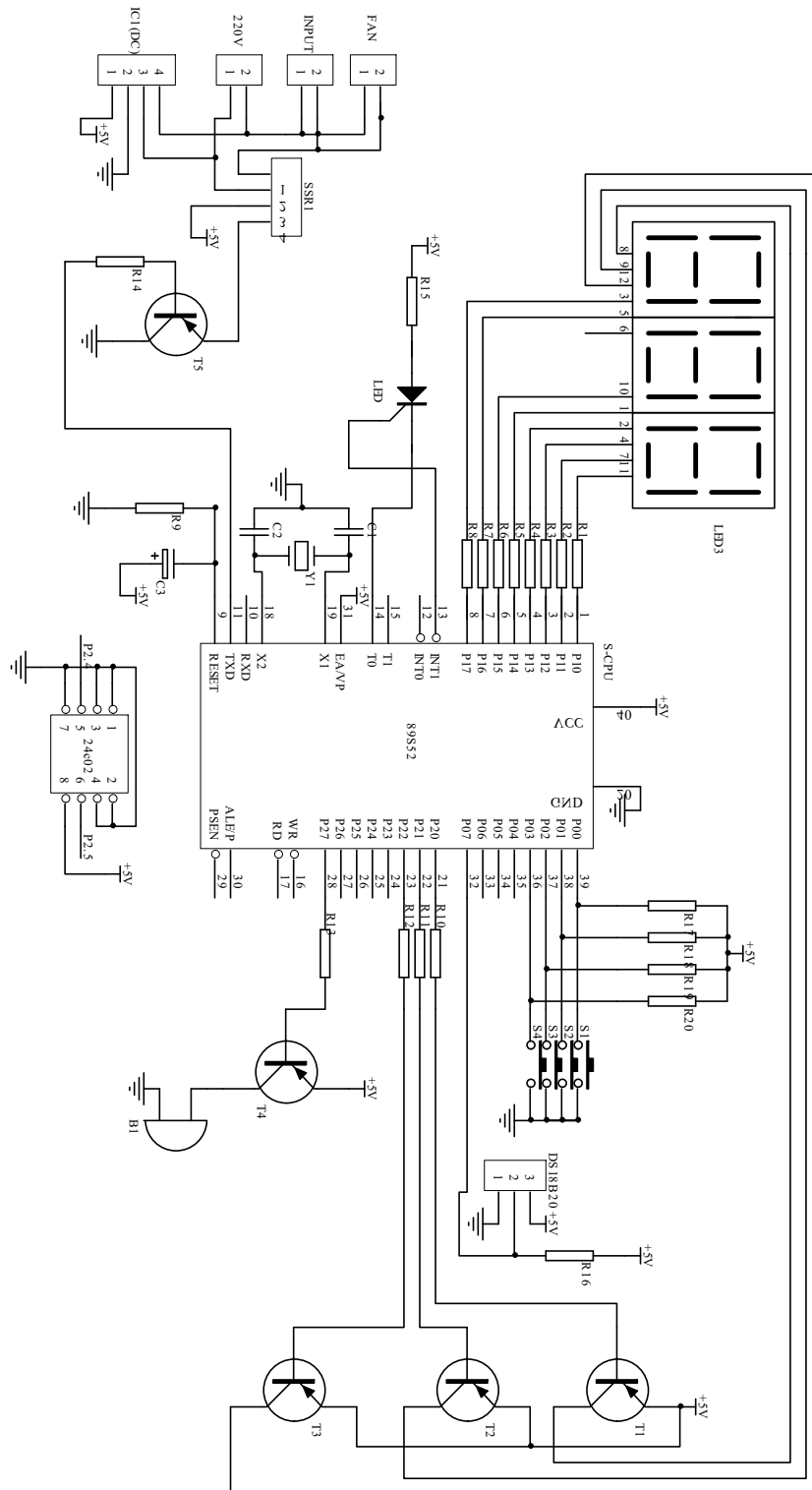



## 8. Cleaning & Maintenance

- Before operation, carefully read the product operation manual and follow its instructions.
- Keep equipment clean. Clean the residuals and dirt after completing tasks.
- Do not use sharp or hard objects that may damage the worktable.
- Installation of fuse as Fig. 4.

Insert fuse (1) into installation part (2) and then place the entire installation part (2) into the socket (3).

- Ensure power is unplugged before replacing the fuse.
- Fuse specifications: 3A (220V), 5A (110V).

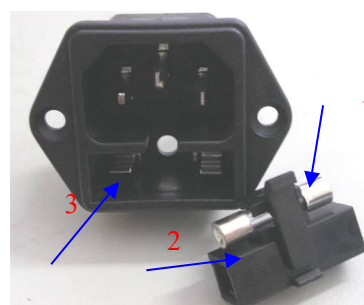

Fig. 4.

## 9. Trouble shooting

Problems		Possible Causes	Judgment Methods	Solutions
No display		Poor connection to power supply	Ensure connection to power supply	Ensure connection to power supply again.
		Power switch wasn't turned on	Turn on power switch	Turn on
		Fuse blow	Take out the fuse to check its internal resistance using a multimeter, if the value is infinite, the fuse is broken	Replace the fuse
Buzzer Alarm	E01 display	Indications of sensor damage, heating film malfunction, or solid-state relay issues.		Replace the broken element
	E02 display	Digital sensor detects temperatures exceeding 100°C.	Solid state relay or sensor is broken	Replace the solid-state relay or fuse with a new one
	E03 display	Digital sensor detects temperature is under -10 °C	Digital sensor is damaged	Replace the temperature sensor with a new one

## Standard Accessories List

No	Accessory Name	Qty	Notes
1	Water bath	1 unit	
2	Power Cord	1pc	
3	Fuse	2pcs	
4	Operation Manual	1pc	

Published by:

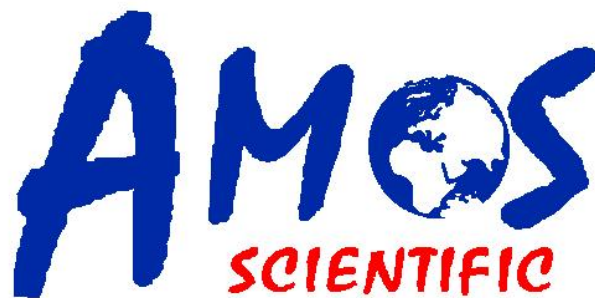

## AMOS SCIENTIFIC PTY.LTD

24/632-643 Clayton Road, Clayton South, VIC 3169 Melbourne, Australia

Tel: +61-410190188

ABN 37 159 778 140

[www.amos-scientific.com](http://www.amos-scientific.com)